



Human
Settlements
in Crisis



Interlocking Stabilised Soil Blocks

Appropriate earth technologies in Uganda



Please send your feedback and suggestions
(including further case studies for consideration) to:

Dan Lewis
Disaster Management Programme
UN-HABITAT
Email: dan.lewis@unhabitat.org

© UN-HABITAT/Adrian Perez



Copyright © United Nations Human Settlements Programme
(UN-HABITAT) 2009

All rights reserved
United Nations Human Settlements Programme (UN-HABITAT)
P. O. Box 30030, 00100 Nairobi GPO KENYA
Tel: 254-20-7623120 (Central Office)
Fax: 254-20-7623477
infohabitat@unhabitat.org
www.unhabitat.org

HS/1184/09E
ISBN: 978-92-1-132150-0

DISCLAIMER

The designations employed and the presentation of the material in this publication do not imply the expression of any opinion whatsoever on the part of the Secretariat of the United Nations concerning the legal status of any country, territory, city or area or of its authorities, or concerning the delimitation of its frontiers of boundaries. Views expressed in this publication do not necessarily reflect those of the United Nations Human Settlements Programme, the United Nations, or its Member States. Excerpts may be reproduced without authorization, on condition that the source is indicated.

ACKNOWLEDGEMENTS

Editorial Team: Mohamed El Soufi, Dan Lewis, Filiep Decorte, Monique Iglebaek, Tom Osanjo, Christophe Lalande, Caylee Hong, Lisa Baumgartner, Dan Andabati, Adrián Mauricio Pérez-Peña

Principal Editor and Manager: Filiep Decorte and Monique Iglebaek
Principal Author: Adrián Mauricio Pérez-Peña
Design and Layout: Adrián Mauricio Pérez-Peña

Photography by Lisa Baumgartner, Peter Donde, Caylee Hong, Adrián Mauricio Pérez-Peña, Manuel Scrima, James Morris, University of Utah, Vetsch Architects

Participating Individuals and Organizations (in alphabetical order):
Arup Consultants: Mathew Bloodworth, Hugh Gray, George Irwin, Ewan Smith, David Williams
BULA Inc: Melissa Fricke and Andrea Procopio
CARITAS: Rev. Fr. Vincent Kisenyi-Byansi and Bro. Kayondo Mathias
Centre for Research in Energy and Energy Conservation in Uganda
Connect Africa Resource Centers: Trevor Tychon
Good Earth Trust: Sophie Mills, Bobby Lambert
Haileybury Youth Trust: Helen Goddard
Joy Center: Rev. Canon Benoni Mugarura-Mutana
Kampala Hospital: Kawalya Kanyereze
Lords Meade Vocational School: Godfrey Kiganga
Makiga Engineering: Ken Shivachi
Malewa Trust in Kenya
Mount Meru Millers Ltd.: R.K. Bharhava
Notre Dame High School
Oyani Women's Group (Kenya): George Tito
Presidential Initiative to Support Appropriate Technology
St. Matia Mulumba Polytechnic
Technology for Tomorrow
The Jane Goodall Institute
UN-HABITAT: Robert Adupa, Peter Donde, David Kithakye, Peter Wegulo



foreword

I am pleased to share with you this publication, which is based on a collaboration between UN-HABITAT and Good Earth Trust (GET). GET is an organisation that promotes the adoption of high quality and environmentally friendly construction technologies in East Africa. By developing and promoting low-cost and sustainable building materials and construction technologies it is therefore contributing to the attainment of the Habitat Agenda and the overall goal of “adequate shelter for all”.

The civil war in Northern Uganda left thousands without homes and stripped the landscape of a good part of its trees and foliage. Inspired by UN-HABITAT’s Strategic Policy on Human Settlements and Crisis, our response has focused on helping to speed up the return of displaced persons and the process of reconstruction and recovery. Putting in place critical infrastructure and services is essential to this task. In a war-ravaged landscape, appropriate construction technologies help to ensure the recovery of the environment which is so essential in supporting people’s livelihoods. Darfur, Eastern Congo, and Somalia are other examples in the region where similar approaches have been piloted successfully and will hopefully be more widely utilized.

This publication also demonstrates how environmentally-friendly building materials and construction technologies can be made more affordable to the urban poor while still meeting rigorous building standards. These techniques also help in mitigating climate change by avoiding carbon emissions during the production of building materials and construction as well as by saving thousands of trees. This publication is intended to help promote the use of earth construction in a wider region where conditions permit, as part of our efforts to address the global challenges created by climate change.

It is my sincere hope that this publication will be a source of inspiration to all those who want to help change the way we deal with our environment while meeting the urgent housing needs of people in places like northern Uganda.



Anna K. Tibaijuka
Executive Director
United Nations Human Settlement Programme
(UN-HABITAT)



preface

Meeting the need for adequate housing of the world's population requires sustained investment and continued innovation, particularly in appropriate technologies that lower the cost of construction and the cost to the environment.

Interlocking Stabilised Soil Block (ISSB) technology is one such technology that is gaining growing recognition, notably in East Africa. Compared with alternatives such as fired brick, it offers lower construction costs at comparable quality, is suitable for a wide range of environments, and dramatically reduces the impact on the environment. With a growing number of organisations using the technology there is a need to improve communication and knowledge-sharing, to quantify and verify the benefits, and to develop efficient approaches for its promotion and adoption.

The purpose of this publication is to promote the use of the technology by sharing some case studies of successful ISSB adoption and adaptation to local contexts. It also highlights some of the challenges faced in developing and promoting the technology with some key lessons learned from the growing amount of practical experience. It is a contribution to the process of information exchange and a tool to build awareness amongst key stakeholders interested in the sustainable development of human settlements.

As the UN agency concerned with human settlements, UN-HABITAT is committed to supporting the development and promotion of this technology. The Good Earth Trust, which is dedicated to the promotion of such technologies and focusing specifically on ISSB, welcomes this publication as an important and timely contribution.

Disaster Management Programme
UN-HABITAT

Good Earth Trust

WELCOME INSIDE
THE
PALACE



introduction

“The building and construction industry is considered a key player in sustainable development, with the potential to significantly impact society and the environment” (Shelter Initiative for Climate Change Mitigation).

There is a need to promote awareness of appropriate construction technologies in civil society and the private sector. Appropriate technologies refer to materials, methods and/or practices which help protect the natural environment, take inspiration from the cultural values and practices in the area, make use of local resources, and contribute to local economic development.

In conflict or disaster affected areas, the natural environment is often seriously degraded due to the direct damages and the overall lack of management and care. Like in Uganda, traditional building techniques often consume a lot of wood and the massive reconstruction needs risk to further accelerate the environmental degradation. An important aspect of “building back better” is the use of appropriate technologies that help preserve the environment, are affordable and create new livelihood opportunities.

This publication discusses the use of Interlocking Stabilised Soil Blocks (ISSB) within the context of Uganda, as an alternative to burned bricks and wattle and daub amidst the return of thousands of displaced and the need for reconstruction of schools and health facilities. This technology makes use of soil for the making of blocks which is naturally or chemically stabilized and then compressed by manually operated or motor-driven machines. This publication deals only with the blocks made with the manually operated machine as it is the most affordable option, more easily transferable to different contexts, and easy to use and maintain. The use of earth for building is already a common practice in Uganda. The production of ISSBs can provide new livelihood opportunities. The benefits of ISSB are manifold and its use versatile.

This publication has been created in order to promote awareness of ISSBs as well as to illustrate the challenges and lesson learned of different organizations in Uganda using this technology. By compiling and gathering data of these different organizations, common challenges can be summarized, providing a way forward to further develop the technology.

Table of Contents

INTERLOCKING STABILIZED SOIL BLOCKS	1
Types of Earth Architecture	2
Development of ISSB Technology	4
SSB Technology General Information	6
Block Production Process	8
Comparative Studies and the ISSB Advantage	10
Construction Methodologies used in Uganda	12
ISSB CASE STUDIES	15
UN-HABITAT Teachers' Housing	16
ARUP Consultants	18
CARITAS	20
Connect Africa	22
HYT	24
PISAT	26
BULA Inc	28
CREEC	30
LESSONS LEARNED	33
WAY FORWARD	39



© UN-HABITAT/Adrian Perez

INTERLOCKING STABILISED SOIL BLOCKS



TYPES OF EARTH ARCHITECTURE



Over the ages, Earth Architecture has always provided communities with basic protection against harsh climatological conditions. The grand mosques of Mali and the Yemeni towns are just two examples of rich cultural expressions of refined civilizations that expressed themselves through Earth Architecture.

Today, Earth has taken a back seat as a material of choice for dwelling construction. Cement blocks and iron sheets are now signs of modernity and progress even in the most remote communities. Traditional construction techniques and forms of expression give way to new 'global' aesthetics, often harming the environment, and producing architecture irresponsible to the climatological and cultural context. Overall, the traditional construction skills needed for working with earth are eroding. In some cases, the over-reliance on wood - which is increasingly hard to get - and recurrent maintenance requirements have helped to speed up the disappearance of Earth Architecture.

Different contextual factors, such as climate, have shaped earth construction techniques. The predominant earth construction techniques are:

Compressed Earth Blocks (CEB) are construction blocks made from a mixture of soil and a stabilizing agent compressed by different types of manual or motor-driven press machines. The Interlocking Stabilised Soil Blocks (ISSB) are a variation on this.



© UN-HABITAT/Adrian Perez

Adobe blocks are similar to CEB's and sometimes tagged as the precursor of CEBs. Adobe blocks are usually made of a compacted mixture of clay and straw, however are less uniform in size and shape than CEB's.



© James Morris

Cob construction does not involve blocks or bricks. Instead a mix of clay, sand and straw is made, then molded and compressed into flowing forms to make walls and roofs.



Rammed earth construction entails the making of a mold into which the soil, inclusive of a weatherproofing agent, is compacted and left to dry. Subsequently, the mold is released and the earthen form remains.



© University of Utah

Earth sheltering refers to the use of earth on the structure of a building; it includes Earth berming, in-hill construction, and underground construction.



© Vetsch Architektur AG

Wattle and Daub consists of a wooden or bamboo frame laid vertically and horizontally reinforced on which earthen daub is packed.



© UN-HABITAT/Adrian Perez



The idea of making blocks by compacting earth or mixing it with stabilizing supplements is an old concept dating back thousands of years. Previously, and still customary in certain parts of the world, wooden molds are used for making sun-dried or burned earth blocks.

A key step in the evolution of this technology was the creation of the CINVA-RAM press in the 1950s by the Chilean engineer Raul Ramirez for the Inter-American Housing Center in Bogota, Colombia (CINVA). Since then, the methods of producing earth blocks has progressed resulting in diverse types of motor-driven and manual presses, and mobile and industrial scale production units.

Even though the CINVA-Ram and other machines of this sort provided a more cost effective and environmentally-friendly solution for block-making, some disadvantages remained. There was still a need for masonry skills to lay the blocks, as well as significant amounts of cement for mortar. The Human Settlements Division of the Asian Institute of Technology (HSD-AIT) along with the Thailand Institute of Scientific and Technological Research (TISTR) combined efforts for the creation of the first interlocking soil blocks by modifying the CINVA-RAM machine in the early 1980s. This new wall construction technique reduced the use of cement drastically, hence reducing final building cost considerably, and enhanced the structural stability of the wall.

Extensive research in appropriate technologies continues in response to the increasing need for affordable and environmentally-friendly shelter options. Technological advances include new types of interlocks, alternative stabilizing supplements that can be added to the soil and further improvements to the press machine. These technological developments allow for ISSB technology to become more competitive due to increased productivity, a more user and environmentally friendly profile, and an enhanced cost effectiveness. In the early 1990s, Dr. Moses Musaaazi, from Makerere University in Uganda, developed a type of double interlocking system and curved blocks for the construction of water tanks.

Soil stabilization refers to the application of additional supplements or forces to the soil in order to make it more waterproof and stronger. The quality of the block depends on the properties and mix of soil types, the amount of force applied for compaction, and the addition of chemical or natural products to further stabilize and strengthen the blocks.

The interlocks increase the structural stability of the wall and reduce the amount of cement needed as mortar. The different types of interlocks have different structural purposes and architectural uses.

ISSB TECHNOLOGY

This specific machine produces blocks with a double interlock.



SSB TECHNOLOGY

The CINVA-RAM was developed after World War II, in a time of shortage and need to save energy. It produces uniform rectangular blocks.



ADOBE TECHNOLOGY

This mold is commonly used in rural areas for making of mud sun-dried or burned bricks. The fermented mud is thrown into the mold to avoid air gaps. However, the final product is not uniform.





ISSB MACHINE

In East Africa, the manual Interlocking Stabilised Soil Block machine is manufactured in Kenya. ISSB blocks are used for the construction of buildings, latrines, wells, septic tanks, and water tanks. This was the machine used in all the case studies in this publication. The main function of the machine is soil compression.

Block quality is not so much defined by the machine but by the quality of the raw materials introduced into the mould, the method used for mixing them and the moisture content of the mix.

There are many factors to be considered when choosing the most appropriate machine. Among these considerations are:

- » Affordability of end product
- » Type and scale of building structures
- » Availability of construction skills
- » Availability of maintenance possibilities
- » Reliability and cost of electricity

The manual machine is the most affordable option for block making and also the most convenient in rural settings due to the fact that it is manually operated and easy to use.

Technical specifications of the manual ISSB machine used in East Africa:

- » Typical compression force: 80-100N
- » Weight: 140kg
- » 2-4 workers in an 8hr work day can produce 400-600 blocks
- » Low maintenance: requires to be lubricated with engine oil.
- » 130 stabilised blocks can be produced from a 50kg bag of cement.

ISSB Blocks

Depending on the machine, different type of ISSB blocks can be produced:

Straight Double Interlocking Block: The most commonly used block for wall creation.

Curved Double Interlocking Block: Used for making water tanks and sanitation facilities.

Wide Format interlocking Block: Allows for stronger, thicker walls, especially useful when making high walls.

Straight Single Interlocking Block: Contains a larger face, hence less blocks are needed to cover wall area. This was the predecessor to the straight double interlocking block.

Grooved Double Interlocking Block: The grooves of this block facilitate plastering, however, this machine is no longer produced.

The BLOCKS



Straight Double Interlocking Block

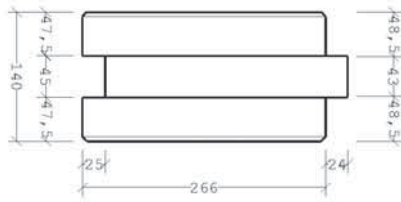

Plan

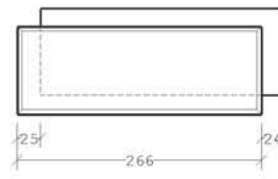

Elevation

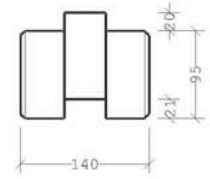

Section



Curved Double Interlocking Block

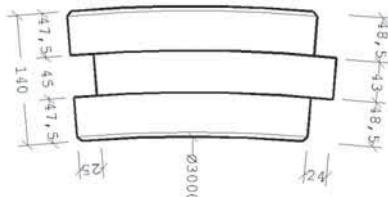

Plan



Elevation

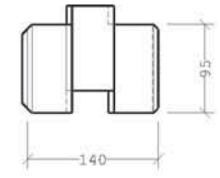

Section



Wide Format Interlocking Block

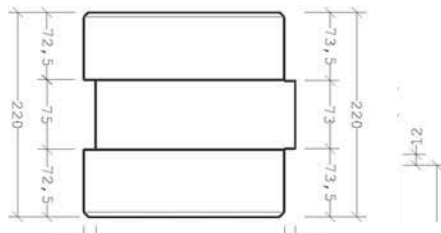

Plan

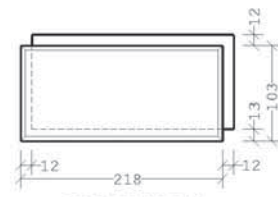

Elevation

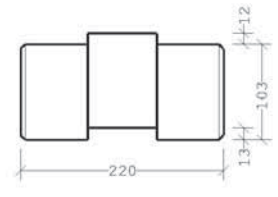

Section



Straight Single Interlocking Block

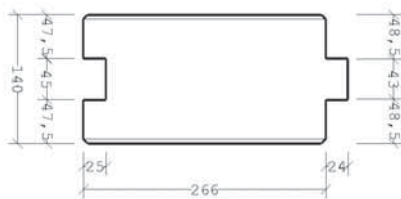

Plan



Elevation

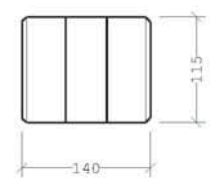

Section



Grooved Double Interlocking Block

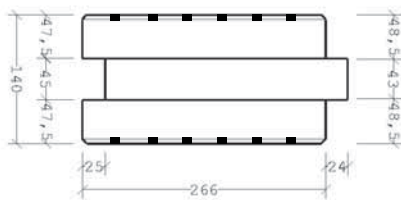

Plan

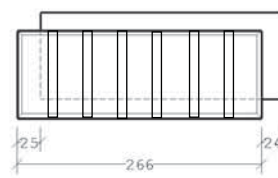

Elevation

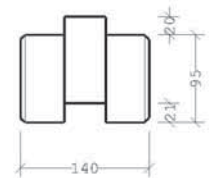

Section

PROCESS ANALYSIS for Cement-Stabilised Blocks

SITE SUITABILITY



Planning the production of ISSBs starts with the site and the properties of the soil there.

SEDIMENTATION TEST

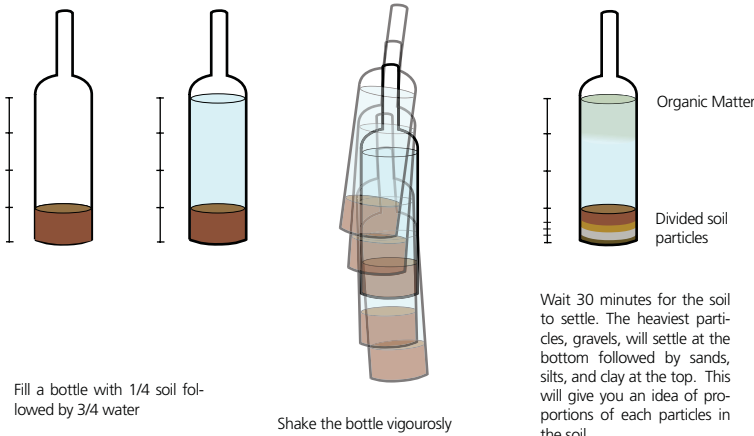

Fill a bottle with 1/4 soil followed by 3/4 water

Shake the bottle vigorously

Wait 30 minutes for the soil to settle. The heaviest particles, gravels, will settle at the bottom followed by sands, silts, and clay at the top. This will give you an idea of proportions of each particles in the soil.

SHRINKAGE TEST

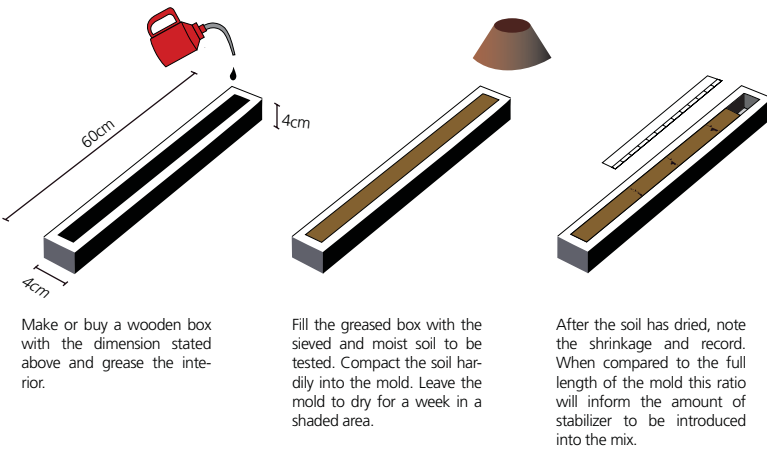

Make or buy a wooden box with the dimension stated above and grease the interior.

Fill the greased box with the sieved and moist soil to be tested. Compact the soil hardily into the mold. Leave the mold to dry for a week in a shaded area.

After the soil has dried, note the shrinkage and record. When compared to the full length of the mold this ratio will inform the amount of stabilizer to be introduced into the mix.

LABORATORY TEST

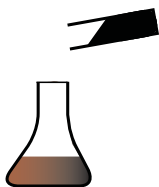

Sending the soil sample to a laboratory to run tests is another option for testing soil suitability.

OTHER TESTS

For other tests, consult the "Earth Construction Handbook" of UN-HABITAT.

CHOOSING A STABILIZER



CEMENT OR LIME: Cement is the most common stabilizer used, however it is not recommended for soils with a high clay or salt content. On the other hand, lime serves very well for high clay content soils.



FIBROUS: Stabilization can be achieved through the introduction of a fibrous reinforcer into the soil mix such as dried grasses, animal hairs, or synthetic fibers.



CHEMICALS & RESINS: At present there are many chemical stabilizers being produced specifically for compressed earth block. There are natural resins and glues that can also be used for stabilization purposes.



SANDS AND GRAVEL: Sands and gravels can be introduced into soils with too much clay content in order to increase its density.

TRAINING OF LABOR FORCE



The making of ISSBs is a process based activity; the steps leading to good soil blocks must all be carefully performed to ensure quality. Training normally takes one to two weeks.

EXCAVATION

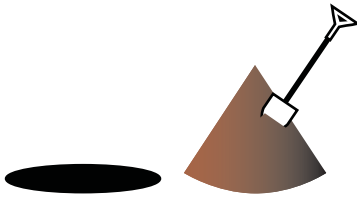

Murram soil is recommended for the making of cement-stabilized blocks. This type of soil is found at sub-levels. Therefore, one must first remove the top soil to reach it.

SIEVING

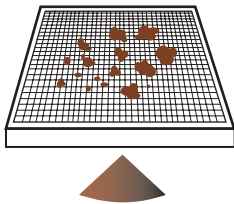

The sieving process is important in order to achieve good compact and smooth finish. To maximize effectiveness allow sieved soil to dry.

MIX PREPARATION

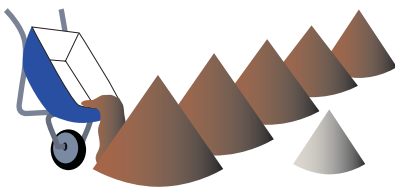

Once the cement-soil ratio is determined by using the shrinkage test, mixing can start. This ratio is measured by the number of wheel-barrows against one bag of cement.

MIXING

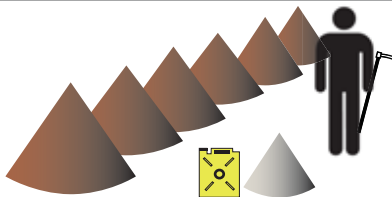

Upon mixing the dry matter, introduce water for wet-mixing. This will activate cement and instigate reaction.

MEASURING THE MIX



Depending on the soil mix, there will be an optimum quantity of it to be introduced into the machine mold to ensure facility of compression and maximum density.

QUALITY CHECK

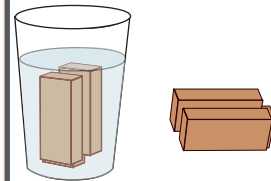

Introduce a fully cured block into a bucket of water for a day to observe its integrity and reaction.

DRY AND STACK

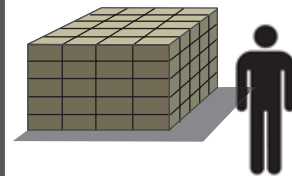

Stack blocks in layers of five and cover with grass or polythene paper. Full curing takes 28 days but blocks can be used before.

REMOVING THE BLOCK



When removing the block, check its texture and quality. If unsatisfied, throw back into the mix.

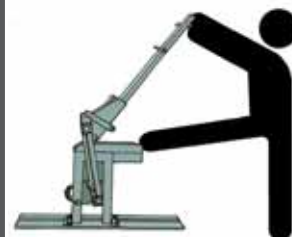

COMPRESSING THE MIX



Machine contains a stop which demarks full compression.

COMPARATIVE ANALYSIS and ADVANTAGES OF ISSB

The advantages of ISSB technology are many and even when compared to other technologies; it is affordable, environmentally sound, user friendly, performs well, versatile in use, among others. However, like with any other construction technology, care must be taken to ensure quality. The quality of ISSB's depends on good and locally available soil selection, a stabilizer to compliment the type of soil, and good practices during production and implementation.

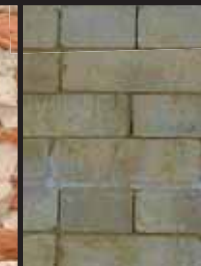
Properties	Interlocking Stabilised Soil Block	Sun-dried Mud Block	Burned Clay Brick	Stabilised Soil Blockb	Concrete Masonry Unit
GENERAL INFO					
Block Apperance					
Wall Apperance (not rendered)					
Dimension (L x W x H) (cm)	26.5 x 14 x 10 cm	25 x 15 x 7 cm to 40 x 20 x 15	20 x 10 x 10 cm	29 x 14 x 11.5 cm	40 x 20 x 20 cm
Weight (kg)	8-10 kg	5-18 kg	4-5 kg	8-10 kg	12-14 kg
Texture	Smooth and flat	rough and powdery	rough and powdery	smooth and flat	coarse and flat
Blocks needed to make up a sq.m.	35	10 to 30	30	21	10
PERFORMANCE					
Wet Compressive Strength (mps)	1 - 4	0 - 5	0.5 - 6	1 - 4	0.7 - 5
Thermal Insulation (W/m C)	0.8 - 1.4	0.4 - 0.8	0.7 - 1.3	0.8 - 1.4	1 - 1.7
Density (kg/m3)	1700 - 2200	1200 - 1700	1400 - 2400	1700 - 2200	1700 - 2200
AVG. PRICE (2009)					
Per Block (UgS)	350	50	150	400	3000
Per Sq Meter	35000	10000	55000	45000	75000

Information for this chart gathered from Craterre publication: "Compressed Earth Blocks :Manual of Production" and GET

HEALTH:

The curved ISSBs are ideal for meeting water and sanitation needs. The curved ISSB can make water tanks, lining for pit latrines, and septic tanks. There are samples of above-ground water tanks of up to 30,000 liters and below-ground of up to 200,000 lts. The final cylindrical shape of the structure and the block interlocking mechanism resists well against water pressure.

ENVIRONMENTAL:

ISSB technology provides an alternative to the commonly used fired brick in Uganda, which currently is the cause of grave environmental degradation due to deforestation, and destruction of wetlands.

ECONOMICAL:

ISSB technology is an affordable way of construction. The bricks are weatherproof hence, there is no need to plaster the building exterior. Also, due to its interlocking mechanism, little cement is needed between block joints and wall construction goes up quickly allowing for labor savings. The machine itself weighs 140kg, making it in cases, easy to transport and work with onsite construction.



ENVIRONMENTAL



ECONOMICAL



HEALTH



EASY TO USE



EDUCATIONAL



STRUCTURAL

EASY TO USE:

The ISSB machine is easy to use and to maintain. After long use, repairs can be made locally through scrap material and welding.

Due to the interlocking mechanism of the blocks, wall construction is much easier and quicker.

AESTHETIC:

ISSB technology is growing in popularity due to its aesthetic qualities, and has been successfully embraced by many communities trained on it. Also, in view that it is an earth technology, as most of the common and traditional methods used in Uganda, it is not foreign to local communities.



AESTHETIC

STRUCTURAL:

ISSB technology has proven to be strong and durable when compared with traditional method of construction. It is suitable for multistory building, has a good compressive strength and in many examples has been used for the retaining wall of buildings.



EDUCATIONAL:

As a new technology, this construction method can increase local skills and become an income-generating opportunity for various populations. It is easy to learn and can stimulate educational dialogue regarding environmental issues due to its nature.

Clay Extraction



© Manuel Scrima

Deforestation



© Manuel Scrima

Firing



© Manuel Scrima

Excessive use of mortar



© UN-HABITAT/Caylee Hong

CONSTRUCTION IN UGANDA: Burned Bricks

Burned bricks are some of the most common construction methodologies used in urban areas. In rural areas, wattle and daub still dominates rural construction in particular for the poor. For many people, a house made of burned bricks is accorded higher status than one made of sun-dried mud blocks or through wattle and daub.

Clay Extraction

Unmonitored soil extraction is damaging to the environment and nearby communities. Burrows left unattended create pools of stagnant water, providing breeding grounds for mosquitoes, fuelling the spread of malaria. Large scale clay extraction also decreases usable land for agriculture.

Deforestation and Firing

The traditional method for burning bricks in Uganda consists of stacking a large amount of dried bricks (up to 20,000) into a large pile with a tunnel opening at the bottom into which large quantities of firewood are introduced and burnt during 24-hours. The pile is plastered with mud in order to reduce heat leakage. This process results in unevenly baked bricks and 20% waste as the bricks closest to the heat source are over burned while those farther away are under-fired.

The large quantities of firewood needed for firing bricks contributes to deforestation, which affects biodiversity. It contributes to air pollution, soil erosion and degradation, desertification of the landscape, and reduces available fuel sources for other human activities. In agricultural regions, these consequences are especially detrimental and contribute to the food crisis and sometimes fuel conflict over the limited resources.

Currently, there are attempts by various organizations to raise awareness on alternative fuels and kiln construction in order to increase production rates and reduce environmental impact.

Excessive use of mortar

Burned bricks are mostly uneven in size, requiring up to 3 centimeters of cement between each brick. Since the walls are not aesthetically pleasing, they are often plastered over which increases the final building cost significantly.

Economy: Unit cost is limited, however, due to the amount of cement needed for mortar and plaster, this construction methodology turns out to be expensive.

Durability: Burned bricks make for durable structures.

Environment: Due to the deforestation and excessive clay excavation involved, burned bricks are environmentally detrimental.

Resistance to Elements: Strong



© UN-HABITAT/Adrian Perez

Adobe

Adobe or sun-dried mud blocks are a common method of construction in the rural areas and are also used in camps for displaced people. They are environmentally friendly. The final aesthetic quality of using sun-dried mud blocks is however considered unpleasant. In addition, there is a need to plaster to extend building life. Plaster techniques are, amongst others sand with mud and a special cassava mix with sand. Direct plastering with cement is expensive and degrades quickly due to the weak adhesion between clay to cement.

Economy: Considering that the main raw material is mud, this type of construction is very affordable. Final cost varies depending on the plaster used.

Durability: If well maintained and plastered, the building can have a long life.

Environment: There is little waste or energy involved making it an environmentally friendly technique..

Resistance to Elements: Weak to medium



© UN-HABITAT/Adrian Perez

Wattle and daub

Wattle and daub is a common practice for low cost housing in Uganda. Plastering is often used to embellish the structures and to extend the life of the building.

Economy: Raw materials are readily available, hence its low cost.

Durability: In view that the daub is not densely compacted, wattle and daub structures require high maintenance hence affecting the building life.

Environment: Use of wood for the structure results in deforestation.

Resistance to Elements: Weak



© UN-HABITAT/Adrian Perez

Concrete

Cement consumption patterns in Uganda have been steadily increasing for the past decade. This type of construction is mainly used in urban areas.

Economy: Concrete construction tends to be expensive.

Durability: Concrete structures are long-lasting.

Environment: A lot of energy is needed to produce cement.

Resistance to Elements: Strong but weak insulation capacity.

© UN-HABITAT/Adrian Perez



ISSB CASE STUDIES: UGANDA





UN-HABITAT:

The mission of UN-HABITAT is to promote socially and environmentally sustainable human settlements and to work towards adequate shelter for all.

Project Abstract:

UN-HABITAT, with funding from UNICEF, implemented this project to facilitate the sustainable return and reintegration processes in Northern Uganda. Through the use of alternative environmentally-sensitive building technology, 64 teacher's housing units in 16 schools and three ISSB demo buildings were constructed in the area.

Structure:

- » 16 ISSB buildings each containing four unit housing blocks
- » 16 ISSB two unit VIP-Toilet blocks
- » 32 unit kitchens made by the benefiting community
- » 3 demo offices, one containing an ISSB water tank

Type of Block Used:

- » Single Interlock
- » Double Interlock
- » Grooved Double Interlock

Contextual Innovations

- » The use of ISSBs at foundation level in form of a double wall.

- » The machines used were previously non-interlocking. Local welders were commissioned to modify the machine molds for the production of interlocking blocks.
- » For the wall construction of the kitchens, the benefiting communities used unstabilized interlocking compressed soil blocks made with the ISSB machines. The use of sun-dried clay soil blocks is a common practice in the area.
- » Tender documents developed for use of ISSB by the private sector allowing further standardization.

Challenges

- » Mobilizing communities to participate in the project.
- » Sensitizing the community on appropriate technologies.
- » Ensuring quality control of blocks produced.

Lesson Learned

- » Intense supervision is needed at the start of the project to ensure block quality.
- » Use of better quality murram taken from more remote locations instead of using local soil increases final cost.
- » Incorporating indigenous construction knowledge leads to innovations and sustainability.

Promoting the Technology

- » Working with private sector (local contractors and masons).
- » Developed a system of lending the ISSB machines and providing training to interested local community and private developers based on an agreement guaranteeing the use of the machine.
- » The construction of ISSB demo buildings as resource centers.



© UN-HABITAT/Adrian Perez



© UN-HABITAT/Caylee Hong



© UN-HABITAT/Adrian Perez



© UN-HABITAT/Caylee Hong



ARUP

ARUP

This consulting engineering firm is one of Ireland's largest. Their work is characterized by innovative and sustainable design solutions, and value-engineering projects. Through the Arup Partnership Worldwide, there are over 10,000 staff working in more than 90 offices in 37 countries.

Project Abstract

The school is located near Pajule town in Pader, Uganda. This area currently houses one of the largest IDP camps in the country. The purpose of the project is to provide a school building and a campus for the Pajule Secondary School which currently shares its premises with the primary school. The new school campus will decongest the existing situation and provide the students with a quality environment conducive to learning.

Structures:

Phase I:

- » Two classroom blocks
- » Two Latrine blocks

Upcoming Phases:

- » Classroom blocks
- » Library
- » Admin Building

Type of Blocks Used:

- » Wide Format Double Interlock

Contextual Innovations

- » As a way of hiding the conventional exposed concrete ring beam, a U-block was developed by fitting a timber piece into the machine to change one of its faces. This U-block contained a larger depressed interlock, in which the ring beam could be concealed.

Challenges

- » No.2 type machines used to produce wider blocks needed more maintenance and repairs
- » At the start, block production was slow as a result of the following:
 - Due to the rainy season, the murrum soil used was wet, making it difficult to sieve.
 - Labor force was new to the technology however, speed increased with time and practice.
 - Availability of suitable soil for block making.
 - Lack of design and technical information.

Lesson Learned

- » Block production is slow when murrum is wet.
- » No.2 type machine needs to be made more robust.
- » Well made blocks have a good finish.
- » Wall construction is quick.
- » More design information is required for more complex structures.

Other appropriate technologies

- » Rain water harvesting from the roof.

Promoting the Technology

- » Employing local labor force for block making and wall construction.
- » Donating ISSB machines to the local community for further use.



WATER TANKS in Luwero



CARITAS Kasana-Luwero CKL:

CKL is the regional branch of a faith-based organization “aiming at contributing to the social, political, and economic development of the masses through various programs and projects that lead to self-sustained development of the individual household in our communities. Since the adoptions of ISSB technology by this organization eight years ago, they have proactively constructed over 600 water tanks in their region, residential quarters within their complex, and a number of homes through a self-developed home financing pilot program.

Project Abstract:

CKL developed a regional program for the provision of water tanks for the local communities. This organization practices cost sharing mechanisms with the household or institution interested in a water tank. The interested party is required to pay 20% of the tank price as well as provide the raw materials (murrum, sand, cement), which the CKL provides the trained masons and technical advice.

Structures:

- » Water tanks

Type of Blocks Used:

- » Curved Double Interlock

Contextual Innovations

- » The development of community programs which enhance quality of life.

Challenges

- » Receiving unsuitable raw material from the benefiting parties.
- » Devising methods of increasing individual and/or organizational ownership of project. Lack of technical data.

Lesson Learned

- » Over the years, ISSB technology has proven to be a sound method of construction for water tanks.
- » Benefiting parties must be sensitized regarding raw material quality.
- » If well made, the blocks are weather-proof, hence do not require plaster.

Promoting the Technology

- » Promotion through project implementation.
- » Providing ISSB training.
- » Loan machines to aid regional development.





Connect Africa:

Connect Africa is a Ugandan faith-based organization promoting and providing local residents with appropriate technologies and training to create sustainable communities.

Project Abstract:

Connect Africa’s activities revolve around “Connect Africa Resource Centers” (CARCs) that serve as a base for training and technological dissemination. At these ISSB community-constructed centers, Connect Africa teams teach local leaders how to use sustainable technologies that in turn help raise the local residents’ quality of life. Currently there are four CARCs, all located in strategic areas in Northern Uganda including Kigumba, Opit, and Atiak; the recently constructed ‘hub’ located near Kampala.

Structures:

- » Each CARC holds a conference room and living quarters for volunteers
- » ISSB water tank(s) & water filters
- » ISSB production unit
- » ISSB Ecological Sanitation toilet (Eco-San)

Type of Blocks Used:

- » Double Interlock
- » Curved Double Interlock

Contextual Innovations

- » The CARC built in Opit four years ago was made of dry-stacked ISSB blocks and has proven sound so far and cost effective.
- » The left-over and unusable ISSB blocks have been used for the creation of a ‘Rocket Stove’.

These stoves are made from recycled oil drums and discarded ISSBs which successfully contain the heat for cooking around all sides of the pot. This process uses approximately 1/7th of the fuel used in traditional stoves, requires less wood for burning, and reduces fire accidents.

Challenges

- » Lack of design and technical data
- » Transportation of machines.
- » Re-use of the cavity after soil excavations.

Lesson Learned

- » Need to plaster building up to window level to avoid block wear
- » Ensuring a good structural connection between the roof and the wall to avoid collapse due to strong winds.
- » Need for design and technical data to aid in construction.
- » It is cost effective to build with ISSB technology.
- » Local communities can be easily trained in block production.

Other appropriate technologies

- » Each CARC contains on-site an ISSB Eco-San toilet. This technology provides an alternative to 'pit-latrines' which contaminates the underground water tables. This toilet contains an above ground collection tank to turn waste into compost and fertilizer.
- » The CARCs in Northern Uganda manufacture and distribute the Bio-Sand Water Filters for treating harvested water.

Promoting the Technology

- » Imparting vocational trainings and workshops on ISSB Technology to local communities.
- » Using community labor force for the construction of the CARCs.
- » Disseminating information through community leaders using the concept of circles of influence.



© UN-HABITAT/Adrian Perez



© UN-HABITAT/Adrian Perez



© UN-HABITAT/Adrian Perez



© Connect Africa



LORD MEAD'S VOCATIONAL SCHOOL CAMPUS

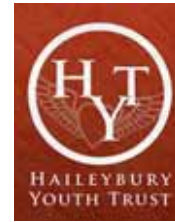

Haileybury Youth Trust:

HYT works with communities to improve quality of life by meeting humanitarian needs, such as housing, education, and access to clean water in an environmentally friendly manner. HYT provides training programs and advocates ISSB technologies. HYT has been involved in over 20 ISSB projects in the Jinja area building water tanks, affordable teachers' housing, classrooms, perimeter walls, dormitories, and schools.

Project Abstract:

The most comprehensive project taken upon by this organization is the development and expansion of Lord's Meade Vocational School containing within its campus samples of all the previously mentioned structures.

Structures:

- » Water Tanks
- » Dormitory building
- » Teachers' housing (bottom left)
- » Double Classroom Block
- » Store
- » Bench (top left)

Type of Blocks Used:

- » Double Interlock
- » Grooved Interlock
- » Curved Double Interlock

Contextual Innovations

- » HYT developed an ISSB training program for the youth of Lord's Mead Vocation School. The students trained in ISSB technology were encouraged to make blocks which would be used in the school's construction projects. They received a small allowance, per block made, helped students to pay school fees, buy supplies, or mostly served as extra spending money.

Challenges

- » Coping with community skepticism regarding the new technology.
- » Developing ways to increase individual or community ownership of the projects.

Lesson Learned

- » Introduction of ISSB vocational training into a school's curricula is a successful way of achieving adoption of new technology and ensuring its use in the future.
- » Technology skepticism can be reduced through constructing visible community structures such as benches.

Promoting the Technology

- » Providing ISSB training to local communities, especially the youth.
- » Promoting the technology through project implementation.
- » Dissemination of information to relevant stakeholders.





Presidential Initiative to Support Appropriate Technology PISAT- under Uganda National Council of Science and Technology UNCST:

The UNCST Vision is “to be the centre of excellence for the management and integration of science and technology into the national development process.

The UNCST Mission is “to provide effective and innovative leadership in the development, promotion and application of science and technology and its integration in sustainable national development”.

Project Abstract

The project objective was to use ISSB Technology to help transform the Rugby pitch into a quality field site, complete with toilets, seating area (stands) and a club house with locker rooms, dining area and VIP area.

Structures:

- » Toilets
- » Stands- seating area
- » Retaining Wall-
Perimeter wall
- » ISSB Water tank

Type of Blocks Used:

- » Double Interlock
- » Curved double interlock

Contextual Innovations

- » The technology is being used to build a retaining wall along the back side of the field. In order to accomplish this, blocks were made with a higher proportion of sand than soil in order to produce strong blocks that can also be left un-plastered. The retaining wall is made using a double layer of ISSB blocks with steel reinforcement, both horizontally placed along the interlock and vertically tying the two walls together, providing added strength to the wall.
- » The conventional concrete lintel was substituted by re-bar at that level.

Challenges

- » The main challenge was to make the wall strong enough to serve as a retaining wall.

Lesson Learned

- » ISSBs can be made strong enough for use in more structurally demanding situations.

Promoting the Technology

- » Visibility- identifying institutions and places where people can see the technology.



© UN-HABITAT/Adrian P. rez



© UN-HABITAT/Caylee Hong



© UN-HABITAT/Caylee Hong



© UN-HABITAT/Caylee Hong

St. KIZITO PRIMARY SCHOOL

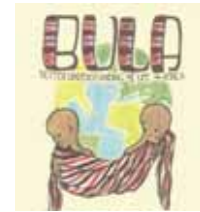

BULA inc.

(Better Understanding Life in Africa)

BULA's mission is to secure brighter futures for African youth through educational support and community development. The construction of St. Kizito Primary School is the first ISSB project completed by BULA.

Project Abstract:

St. Kizito Primary School is located in the outskirts of Kampala in Gganda. The vision and execution of the project was a collaborative effort of the school management, local leaders, and BULA. By engaging the local community, BULA initiated and managed the reconstruction of this school. Supplies and labor were provided by the community. The purpose of this project was to firstly provide the children with proper educational facilities for learning and additionally, to strengthen the ties and organizational skills of the community.

Structures:

- » 8 ISSB classrooms; Nursery to P7 (150 Students)
- » Two ISSB teacher offices and a staff room
- » A 30,000 gallon underground water tank and a 5000 L above ground tank
- » Solar powered lighting
- » Toilet facilities
- » A kitchen

Type of Blocks Used:

- » Double Interlock

Contextual Innovations

- » The cavity left due to soil excavation became an underground 30,000 gallon water tank for the school and community

Challenges

- » Importing of some murrum to ensure block quality due to the high levels of the clay in the soil on-site.
- » Supervising of newly trained block-making/laying crew to ensure block quality and use of cement during wall construction.
- » Lack of technical information regarding wall construction and block production leading to trial and error solutions.
- » The two machines hired for block making produced blocks that varied in quality and size.
- » The machine required constant maintenance with regards to lining of PVC and oil to prevent the soil from sticking.

Lesson Learned

- » Need for close supervision at the early stages to ensure quality control.
- » Building with ISSB technology is time-effective; the project was completed in 5 months
- » A good use of the cavity left after soil excavation as an underground water tank and pit latrine
- » Using mostly local labor increases community pride and ownership of the project

Other appropriate technologies

- » The light of this complex is powered by solar panels on the roof.
- » All of the harvested rain water is treated through the use of Bio-Sand water filters. The school has developed a system for water treatment using color-coded containers: yellow for untreated water, blue for clean water.

Promoting the Technology

- » Employing local community labor force and introducing the technology to local leaders and officials
- » Commitment to use ISSB technology for future schools and construction projects
- » BULA promoted awareness via the internet and through community and youth awareness programs





**Centre for Research in Energy and energy Conservation
CREEC**

The goal of CREEC is to create capacity in all fields related to energy with a special focus on energy management, solar photovoltaic, hydropower, and biomass.

The aim is to develop technologies and systems that have a direct, positive impact on people's everyday lives.

Project Abstract:

To strengthen CREEC's efforts in the field of biomass energy and to improve their research facilities, this new laboratory space was constructed. It will be called the Biomass Research Centre. In addition to tests with biomass and fuel-efficient stoves, the facility will be used to test and validate electrical materials and equipment for local markets, in conjunction with the Uganda National Bureau of Standards.

Structures:

- » Laboratory Facility
- » ISSB Water tank

Type of Blocks Used:

- » Double Interlock
- » Curved Double Interlock

Contextual Innovations

- » The Labs make use of natural light by adding in some clear plastic sheets as roofing material
- » Since this will be a lab and testing facility of fuel-efficient stoves, special ventilation has been catered for on the sides of the building

Challenges

- » The main challenge was ensure quality control of the blocks

Lesson Learned

- » There was an easy skills transfer in terms of masonry skills.
- » There was a cost savings of 30%

Promoting the Technology

- » Promotion of the technology through project implementation



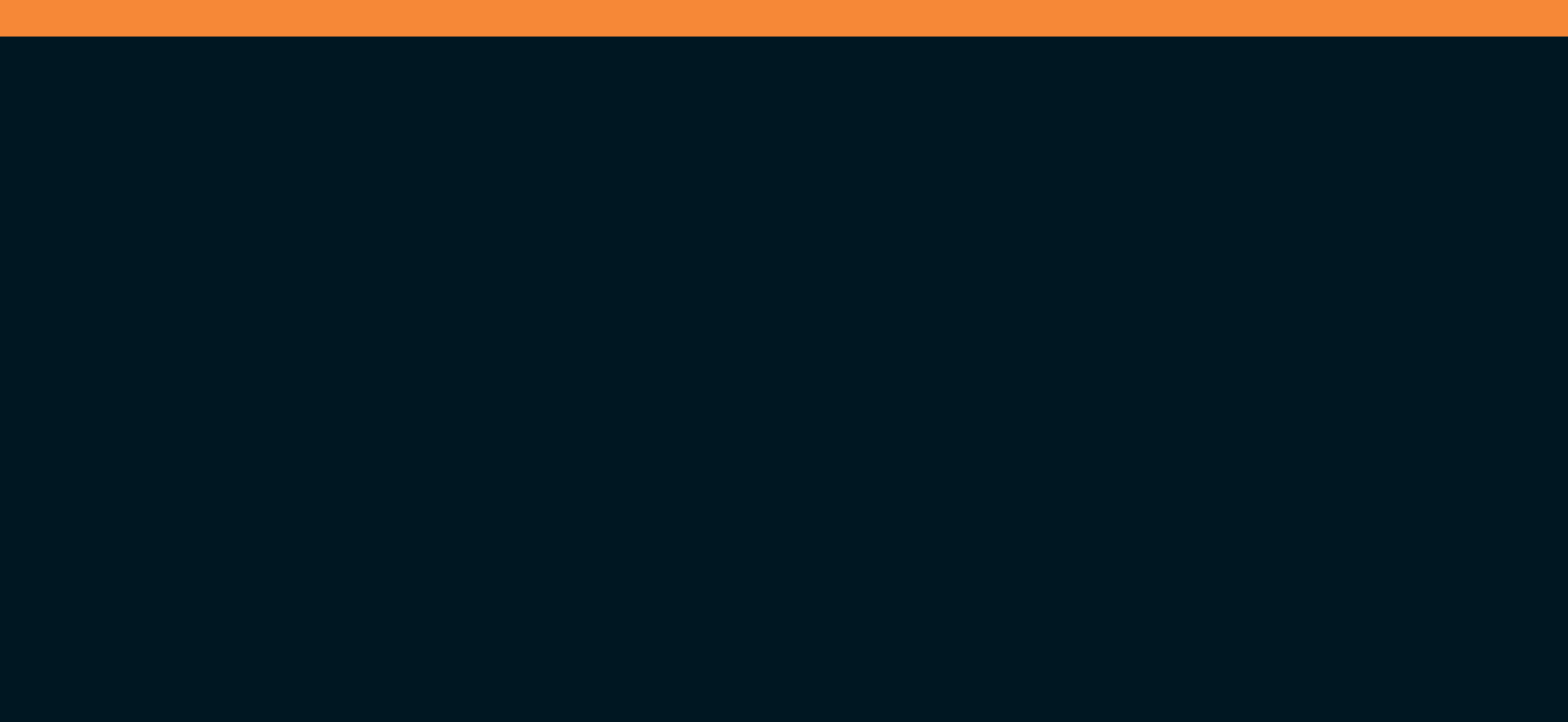



© UN-HABITAT/Caylee Hong

LESSON LEARNED



© UN-HABITAT/Adrian Perez



© UN-HABITAT/Caylee Hong



© UN-HABITAT/Caylee Hong



© UN-HABITAT/Caylee Hong

Standardization required

Technical data of ISSB technology is still insufficient, leading to skepticism of the technology amongst construction industry professionals. The technology has not yet been standardized in Uganda. The Good Earth Trust is coordinating with the Uganda National Bureau of Standards to produce standards for ISSB technology following the Kenyan example. This is expected to be finalised in 2009. In order to ease the integration of ISSB technology into more densely-populated urban areas, there is a need to produce more technical data including quality tests and appropriate building codes and standards. Standardizing and publicizing technical data is essential to promote use amongst professionals in the building industry. Sufficient technical data should also help to promote building techniques maximizing the advantages of ISSB, instead of using ISSB in conventional ways (e.g. with mortar instead of a fitted joint).

Integration into educational curricula needed

ISSB technology has not been integrated into the educational curricula of secondary vocational institutions and tertiary engineering and architectural institutions. This is the most effective way of ensuring the technology's use in the future. At present, one of the key challenges is changing the mentality of the companies and individuals already manufacturing and using the conventional methods of construction such as burned bricks and concrete blocks. Due to their popularity, graduates of different educational programs are being trained to suit the needs of the industry at hand. As a new technology, ISSB is therefore at a disadvantage due to the lack of trained professionals. In order to increase and ensure future use of ISSB technology, especially in urban areas, more young professionals need to be trained in its use. In addition, introducing ISSB education into the curricula will encourage further research.

3.2.3 Education

Ignorance, lack of access to information, and education on environmental topics, especially those related to sustainable construction, are present at all levels. Raising public awareness on environmental and equity issues is indispensable for sustainable development. For successful implementation of comprehensive and appropriate development issues, it is essential to educate the public, governments, social and technical institutions and business groups about comprehensive sustainability issues. Just as an individual understands the implications of his daily financial decisions, similarly he should be cognisant of the social and environmental implications of his actions.

Two main problems exist in the current education system. The first and most important one is a lack of integration of these efforts within the education system, since development as well as research in the field of sustainable human settlements and construction is not linked to the academic institutions. At best, any change and development work continues to remain one of many pilot projects or "alternative" options. Their propagation at a mass level is hindered by the lack of appropriately trained professionals within the profession, government agencies and amongst the educators themselves. This lack of awareness also exists amongst the general public.

Agenda 21 for Sustainable Construction in Developing Countries

Local economic development models to be explored

There is a need to further sensitize community groups and vulnerable communities in regard to business and self help opportunities using ISSB.

Research to be extended

Alternative stabilizers and soil mixtures

The most common method of making the blocks is through the mix of cement or lime (stabilizer) and murram soil, compressed in the ISSB machine. However, in areas where insufficient amounts of murram are available and cement or lime proves to be too expensive, affordability can be a problem. There are several other potential stabilizers and soil mixes, which after compression can produce structurally-sound, cost-effective, and environmentally-friendly soil blocks. Compression itself is already a stabilizing agent.

Facilitating transport of ISSB machines

The ISSB manual machine is the most cost-effective and accessible way of making soil blocks. Nonetheless, there is potential for further decreasing its costs and facilitating its use. In rural areas with limited access, transportation of the machine was challenging due to its weight (140kg) mostly necessitating motorized transport. Some have managed to transport it by bicycle, using a number of people to slowly guide the bike to the construction site. Ways need to be explored to increase mobility of the machine by facilitating for instance, easy dismantling and re-assembling.

Adaptable wall construction

A common challenge found with ISSB technology, similar to other construction techniques, is the introduction of the electrical and plumbing systems. In most cases, walls have to be chiseled in order

to allow these systems to traverse the building. New architectural design techniques or adapted interlocking block types could be developed.

Building stability in earthquake-prone regions needs to be improved through, amongst others, the introduction of vertical rebar. Research is ongoing at Makerere University in Uganda.

Need for adaptable blocks

The interlocking mechanism reduces the necessary time for wall construction. However, for corner, intersecting and Y wall connections, there is a need to break the block. By making a machine mold with additive pieces to change final block shape, there ceases to be a need to break the blocks after curing. Alternatively, a block-slicing apparatus could be developed for breaking the block before the curing process in order to maintain a neat final finish.

Need for alternative plastering techniques

In Uganda, it is common to plaster the building walls with cement, which is expensive and unaffordable for low-cost housing. More research is needed to provide populations with effective, affordable and environmentally friendly techniques to protect walls against wear and tear.

Using ISSB for other building elements

Currently, the use of ISSB technology is mostly restricted to building walls and water tanks. In customary shelter construction in Uganda and other countries, the wall is not the most expensive building component. The roof generally makes up to 50% of the final building cost, and the foundation is the most laborious activity. For roof construction, ISSBs could be used in the context of arches, vaults and/or domes. As for the foundation, there are already examples in Uganda where strengthened ISSBs have been used for the retaining wall.



© UN-HABITAT/Adrian Perez



© UN-HABITAT/Adrian Perez



© UN-HABITAT/Caylee Hong

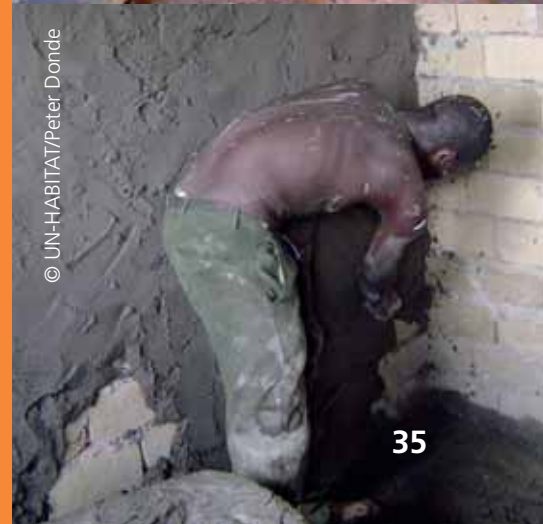

© UN-HABITAT/Peter Donde



© UN-HABITAT/Adrian Perez



© UN-HABITAT/Caylee Hong



© UN-HABITAT/Adrian Perez

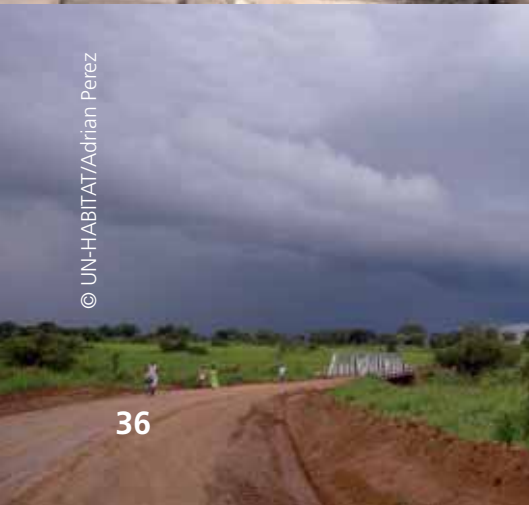

© UN-HABITAT/Adrian Perez

Further improving affordability

Compared to other construction methods such as burned brick and concrete block construction, ISSB technology has proven to be less expensive if implemented correctly.

- » Most savings are attributed to the reduced use of cement mortar needed between the block joints due to their interlocking mechanism. In addition, the interlocking mechanism allows for faster wall construction, resulting in labor savings. First time use of the technology can be time consuming, however, time saving comes with practice.
- » There is no longer a need to fully plaster the building wall due to the neat block finish and its weather resistance. Proper drainage systems and roof overhangs can help to protect the walls.
- » ISSB technology allows for on-site construction which reduces cost for transportation.
- » In order to ensure cost-effectiveness with cement stabilized blocks, soil selection and testing are fundamental. The better the soil, the less cement has to be introduced into the mixture.
- » Blocks made from the wide format machines are more expensive due to the fact that more material is used per block and should only be used where the advantages outweigh the cost.
- » Alternative stabilisers, replacing cement in the mixture, could help to further reduce the cost. The cost per square meter for ISSB is still too expensive if compared with the traditional techniques used in rural areas. However, the use of compressed soil blocks without additional stabilisers already provides improved construction techniques.

Need to consider timing

Avoid the rainy season

Some seasons will be better than others to produce blocks. During the rainy season, the wet soil makes it harder to sieve, requiring additional measures. Sieving is an important process in the production of ISSB. It facilitates compression and ultimately makes for more compact and sturdy blocks.

Align with agricultural seasons

The agricultural cycles must be respected. Right before the rainy season, all efforts of the agricultural society are mainly invested in planting; there is little construction during this time. Most traditional construction happens during the dry season when the crops have grown to full size and are ready to be distributed.

Building on indigenous knowledge

It is important to take into consideration the tacit local knowledge to ensure the technology's adoption. In Uganda, the use of earth is already a conventional method of construction widely used throughout the country and affected populations have a good understanding of the use of certain types of soils for traditional block making. This creates the opportunity for ensuring sustainability with respects to the successful integration of the technology. An area assessment evaluating local resources and traditional construction techniques should be performed before new technologies are introduced, looking at the raw materials available, local skills, and indigenous methods of construction.

More networking amongst stakeholders

There are a variety of groups using ISSBs in Uganda, each building up their own experience with the ISSB technology. There is a need to develop information sharing mechanisms in order to facilitate further improvements and the further spread of the technology. A database of ISSB projects is being established. Good Earth Trust intends to serve as a hub for guidance and advocacy.

Need for quality control

Malpractice with ISSB can easily lead to the technology's demotion. Consequently, it is crucial to provide users of ISSB technology with more accessible resources and appropriate knowledge regarding block production and use. Ways of ensuring project quality should be developed. This includes extended training and monitoring, more accessible literature and information, or establishing a network of successful ISSB users per region.

Use of ISSB in crisis affected regions

Due to the higher environmental degradation, reduced availability of traditional materials, and the urgent need for construction materials in post-conflict and disaster regions, appropriate technologies that make use of immediate local and more environmentally friendly resources are most suitable in this context. ISSB technology has proven successful with respect the recovery and reconstruction efforts in post-conflict areas of Uganda. It also provides an opportunity for job creation in the affected regions.

Further promoting the technology with different stakeholders

There is a need to elevate the profile of the technology, It is increasingly categorized as a building material for low-cost housing and consequently mistaken as low-quality. Using the technology in more ostentatious projects will help to challenge these assumptions.

Local culture and traditions may affect the attitude towards ISSB technology and the general comprehension of processes involved in block production and use. The technology should be promoted in a culturally-responsive way, so as to promote its use also in self help construction.

The private sector plays a key role in expanding the use of ISSB technology in Uganda. At present, there are still too few completed examples of ISSB structures built by the private sector, especially in the urban areas. This is partially due to the fact that standardization has not been fully achieved. There is a need to promote environmental principles in the private sector alongside arguments of cost and time efficiency. Aside from adding legitimacy to the technology, it will support sustainable urbanization as the private sector is the main actor in construction.



© UN-HABITAT/Adrian Perez

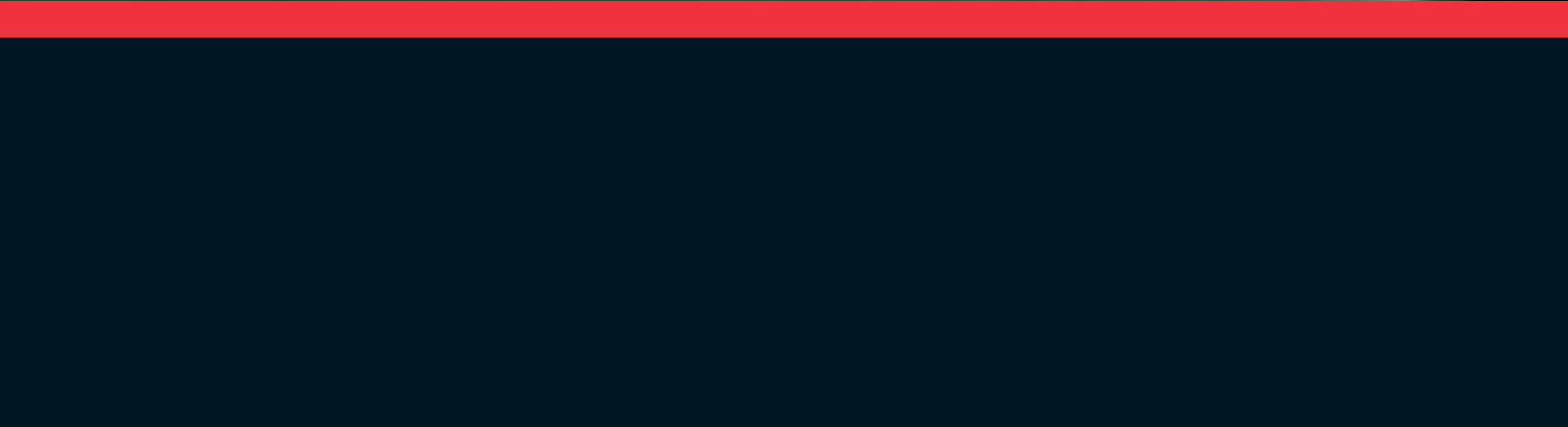



© UN-HABITAT/Adrian Perez

WAY FORWARD

WAY FORWARD

STANDARDIZE

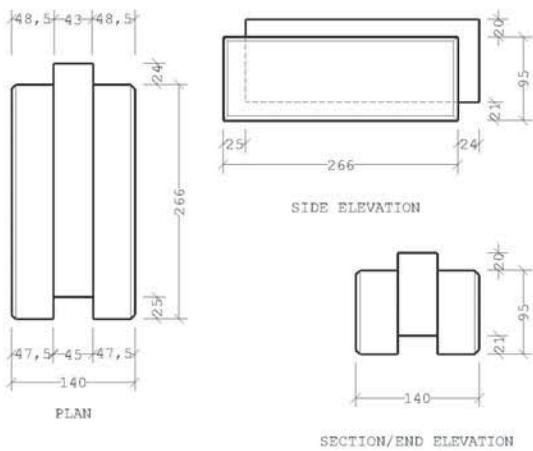

- » Finalize the creation of National Standards and generic tender documents, allowing diverse use of the technology taking into account affordability.
- » Produce a maintenance and construction manual.
- » Liaise with Ugandan Ministry of Education for the introduction of ISSB technology into vocational training colleges and tertiary educational institutions.
- » Development of educational modules to aid in the teaching of ISSB technology in vocational and tertiary institutions.

RESEARCH



Encouraging further research and experimentation in the following areas:

- » Alternative environmentally friendly plasters.
- » Alternative stabilizers for soil mixture.
- » Increasing transportability of the machine.
- » Use of ISSBs in other building elements such as roof and foundation.
- » Develop ISSB specific architectural details.

CONTEXTUALIZE



- » Develop a standard method of assessing an area prior to ISSB technological deployment.



EDUCATE

- » Increase levels of awareness amongst the community at large with respects to appropriate technologies and sustainable living.
- » Teaching through project implementation such as demo projects,
- » Build capacity at all levels.
- » Introduce ISSB technology into the educational curricula.

© UN-HABITAT/Adrian Perez



MONITOR

- » Increase efforts to monitor the various projects using ISSB technology in order to ensure correct implementation and to record best practices for furthering the technology's development.

© UN-HABITAT/Adrian Perez



PROMOTE

- » Develop culturally responsive promotional approaches including manuals in the local languages, and establish resource centers in strategic locations.
- » Increase awareness of alternative stabilization processes to make the technology more contextually flexible, easily implementable in a range of diverse settings and making it more affordable.
- » Promote the use of ISSB technology in more ostentatious projects to showcase its qualities.
- » Augment promotion efforts of the technology in urban areas through the private sector.
- » Develop business models for the development of income generating activities using ISSB technology.
- » Create special programmes for the conversion of the burnt brick producers.

© UN-HABITAT/Caylee Hong

FURTHER READINGS

Books and Publications

Andabati, D. (2009). Construction Manual. Double Interlocking Rectangular Blocks for House Construction. Good Earth Trust.

CIB & UNEP-IETC. (2002). Agenda 21 for Sustainable Construction in Developing Countries, A discussion document. Pretoria: CSIR Building and Construction Technology.

Guillaud, H., Joffroy, T. & Odul, P. (1995). Compressed Earth Blocks :Manual of Design and Construction. CRATerre-EAG, Aus der Arbeit von GATE. Germany: Braunschweig Vieweg.

Rigassi, V. (1995). Compressed Earth Blocks : Manual of Production. CRATerre-EAG, Aus der Arbeit von GATE. Germany: Braunschweig Vieweg.

UN-Habitat. (1992). Earth Construction Technology. Nairobi: UN-Habitat.

Yager, T. (2004). The Mineral Industry in Uganda. U.S. Geological Survey, National Center: Virginia.

Articles

Prussian, Labelle. (1974). An Introduction to Indigenous African Architecture. The Journal of the Society of Architectural Historians, Vol. 33, No.3, 183-205.

Online periodical and publications

CRATerre Editions. (2005). Earth Architecture in Uganda: Pilot Project in Bushennyi. Online: www.craterre.archi.fr.

Deutsches Zentrum für Entwicklungstechnologien-GATE. (1991) The Basics of Compressed Earth Blocks. Online: www.basin.info/publications/books/Basics_of_CEB.pdf.

International Strategy for Disaster Reduction. (2008) Indigenous Knowledge for Disaster Risk Reduction: Good Practices and Lessons Learned from Experiences in the Asia-Pacific Region. Online: www.unisdr.org

Maini, Satprem. Earthen Architecture for Sustainable Habitat and Compressed Stabilized Earth Block Technology. Retrieved March 2009 from www.auroville.info/ACUR/documents/envi_urb_pres/satprem_cpdc.pdf.

Practical Action. Alternative to Portland Cement, A technical brief. Retrieved March, 2009 from www.practicalaction.org

Practical Action. Mud as Mortar, A technical brief. Retrieved March, 2009 from www.practicalaction.org

Weinhuber, K. (1995). Building with Interlocking Blocks. German Appropriate Technology Exchange. Retrieved March 2009 from www.fastonline.org

Other

Good Earth Trust. (2009). Good Earth Trust ISSB Project Database. Uganda.

Perez, Adrian. (2009). Mission Report, ISSB Technology in Uganda. Disaster Management Programme. UN-Habitat

UN-Habitat Regional Office Lira (April 2009). ISSB Workshop Lira. Uganda

INTERLOCKING STABILISED SOIL BLOCKS
Appropriate earth technologies in Uganda

Interlocking Stabilised Soil Block (ISSB) technology has been gaining recognition, particularly in East Africa. This material and method of construction has the advantages of low cost and minimal environmental impact, while providing comparable quality to conventional fired brick construction. With a growing number of organisations using the technology there is a need to improve communication and knowledge-sharing, to quantify and verify the benefits, and to develop efficient approaches for its promotion and adoption.

The purpose of this publication is to promote the use of ISSB by sharing some case studies of successful adoption and adaptation to local contexts. It also highlights some of the challenges faced in developing and promoting the technology with some key lessons learned from projects in northern Uganda. This document provides stakeholders interested in the sustainable development of human settlements with a reference tool for an innovative construction method in practice.

HS/1184/09E
ISBN: 978-92-1-132150-0

UN-HABITAT
P. O. Box 30030
00100 Nairobi
GPO KENYA
Tel: 254-20-7623120
Fax: 254-20-7623477
infohabitat@unhabitat.org
www.unhabitat.org

Printing: UNON, Publishing Services Section, Nairobi,
ISO 14001:2004-certified